

# **Dimplex<sup>®</sup>**

## **PORTABLE AIR-CONDITIONER**

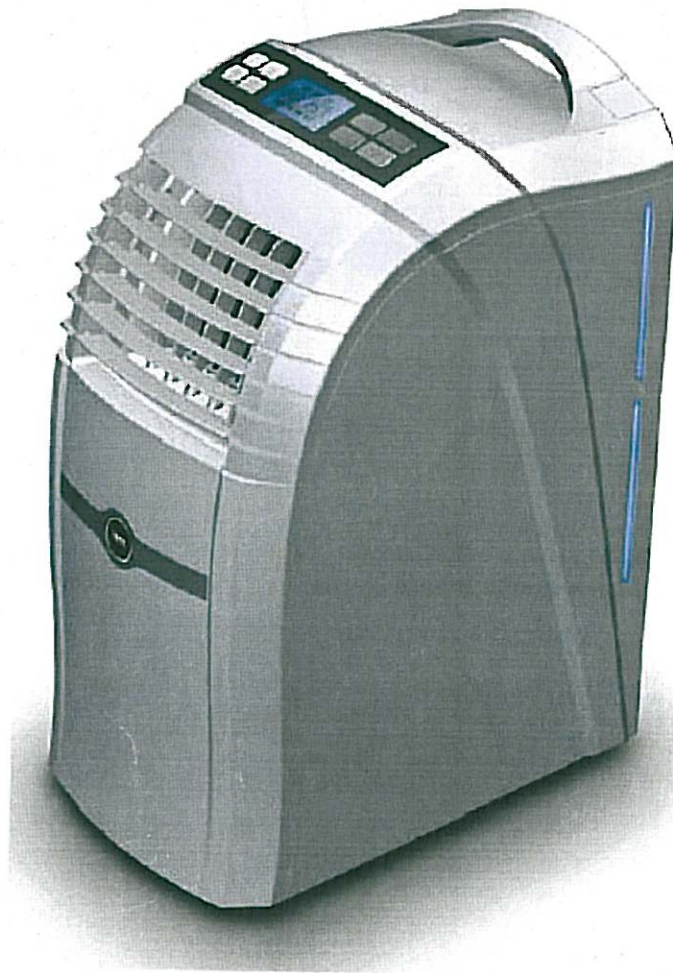

### **Model DAC15HC and DAC15HH**

*☆Please read and retain this manual for future reference*

## Contents

Introduction.....	2
Important Safeguards .....	3
Energy Saving Tips .....	3
Features And Parts List .....	4
Installation .....	5
Control Panel.....	7
Key Functions.....	7
Remote Control .....	8
Operating Instructions .....	8
Water Drainage .....	10
Maintenance .....	10
Trouble Shooting .....	11

## Introduction

Thank you for choosing a Dimplex air conditioner. This manual contains information, regulations and warnings which are of fundamental importance if the appliance is to be installed correctly and the highest performance, in the safest possible conditions is to be obtained. We suggest that you read the manual carefully before installing or starting up the appliance.

The air-conditioning unit is of the mono tube type, transferable (on wheels) with air/air operating system for domestic use and has 3 settings:

- Ventilate.
- Cool.
- Dehumidify.
- Heating.

The ventilation mode "moves" the air allowing for its recycling much like a fan.

The cooling mode, a refrigerated circuit (compressor), cools the room by transferring the heat from the inside to the outside through the air exhaust hose. While cooling, the air-conditioning unit also dehumidifies the room air.

## Important Safeguards

- Read all instructions.
- Disconnect the power plug before dismantling, assembling or before cleaning.
- Avoid touching mobile parts of the appliance.
- Never insert fingers, pencils or any other objects though the guards whenever the power plug is connected, especially while running.
- The appliance is not intended for use by young children or infirm persons unless they have been adequately supervised by a responsible person to ensure that they can use the unit safely.
- Young children should be supervised to ensure that they do not play with the appliance.
- Do not use the appliance for any other purpose than its intended use.
- The appliance must not be used if the guards are not fastened according to instructions.
- When the power cord is damaged, it must be replaced by the manufacturer or its service agent or a similarly qualified person in order to avoid a hazard.
- Do not use your appliance with an extension cord unless it has been checked and tested by a qualified electrician or electrical supplier.
- Return to Hagemeyer or authorised service agent.
- **The air conditioning unit must always be stored and transported upright, otherwise you may cause irreparable damage to the compressor; in case of doubt we suggest to wait for at least 24 hours before you start the air-conditioning unit.**
- Avoid restarting the air conditioning unit unless 4 minutes have passed since being turned off, or the compressor may get damaged.
- Never use the mains plug as a switch to start and turn off the air conditioning unit. Use the provided ON/OFF switch located on the control panel.
- Always place the portable air conditioner on a dry stable surface.

## Energy Saving Tips

- Do not cover or restrict the airflow from the Outlet or Inlet grills.
- The minimum distance from furniture and wall should be 50cm.
- Keep blinds and /or draperies, on any windows, closed during the sunniest part of the day.
- Keep the filters clean. Under normal conditions, the filters should be cleaned approximately every 30 days. Since the filters remove airborne particles, more frequent cleaning maybe necessary, depending on the indoor air quality.
- Set the fan speed switch to high cool and the thermostat to the coolest position for the initial start-up, then set the Fan switch to Low cool and lower the thermostat to a comfortable setting.

## Features And Parts List

### Features:

- No installation is required.
- Easily moved with castors and handle.
- Control panel with LCD display.
- Remote control.
- Water-cooled mode can save running costs.
- Low noise and strong breeze.
- Auto swing for better air movement.
- On/off timer function.
- Three-minute restart delay to protect compressor.

### Parts List:

1. Control panel
2. Horizontal louvre
3. Vertical louvre
4. Handle
5. Air-inlet grille
6. Castors
7. Exhaust pipe
8. Water injection port
9. Power cord storage hooks
10. Air filter
11. Air-outlet grille
12. Connector to outer water tank
13. Inner water tank
14. Power cord

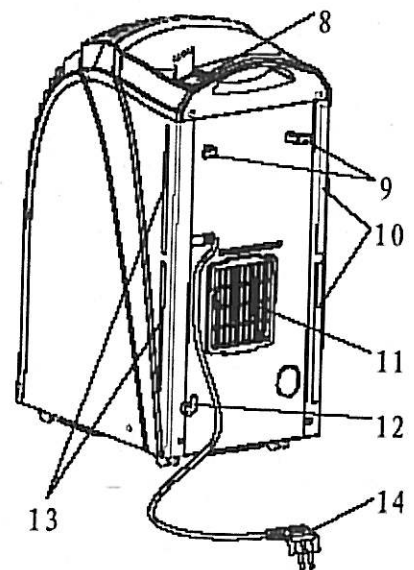
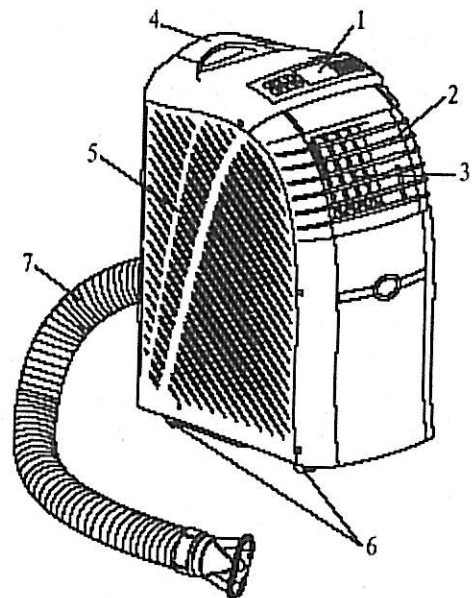

### Accessories:

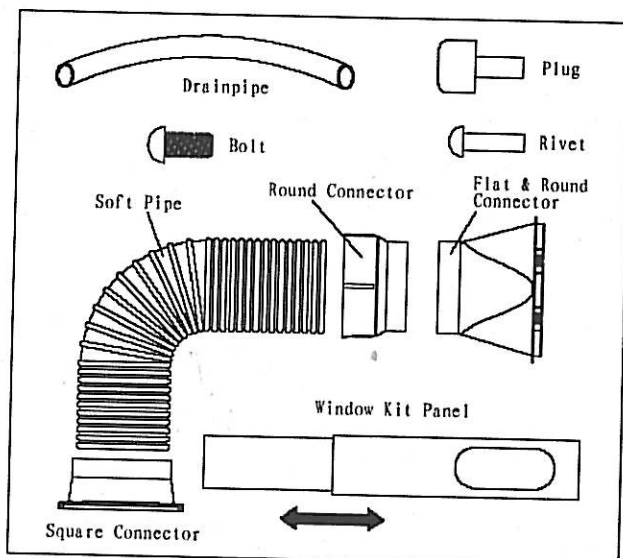

## Installation

**Before you use this unit please ensure it has been kept upright for at least 2 hours.**

1. The unit should be installed in a flat dry place. Leave at least 50cm space around the unit (Fig. 1).
2. Fix the exhaust hose adapter to the exhaust terminal of the unit (Fig. 2).
3. Screw one end of the exhaust hose into the exhaust hose adapter and screw the window exhaust adapter to the other end of the exhaust hose.
4. The window kit has been designed to fit most standard vertical (Fig. 3) and horizontal (Fig. 4) windows. However it may be necessary for you to modify some aspects of the installation procedures for certain types of windows. Once the window kit is in place, simply snap the window exhaust adapter into the hole provided on the window kit. You are now ready to use your portable air conditioner.

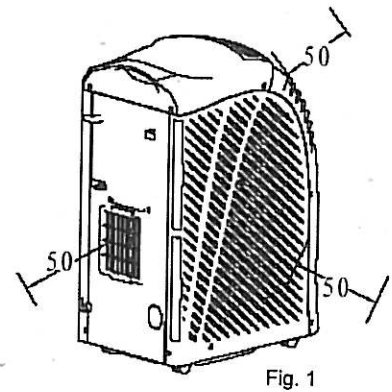

Fig. 1

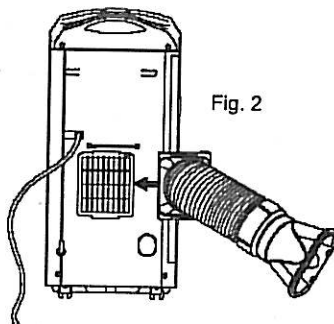

Fig. 2

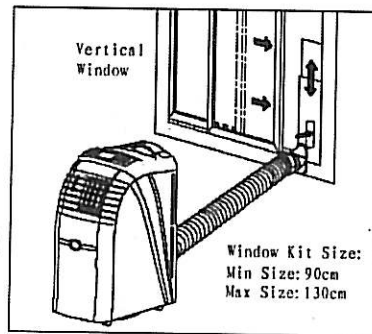

Fig. 3

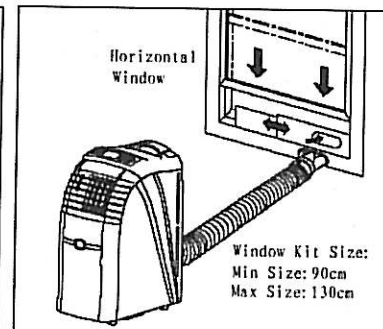

Fig. 4

### 5. Permanent installation (Fig. 5)

- Fix the exhaust hose adapter to the exhaust terminal of the unit and screw in the exhaust hose.
- Make a round hole with the diameter more than 120mm, then input and fix the window kit adaptor.
- Fit the supplied round adapter on the air outlet duct then connect it with the Cover.

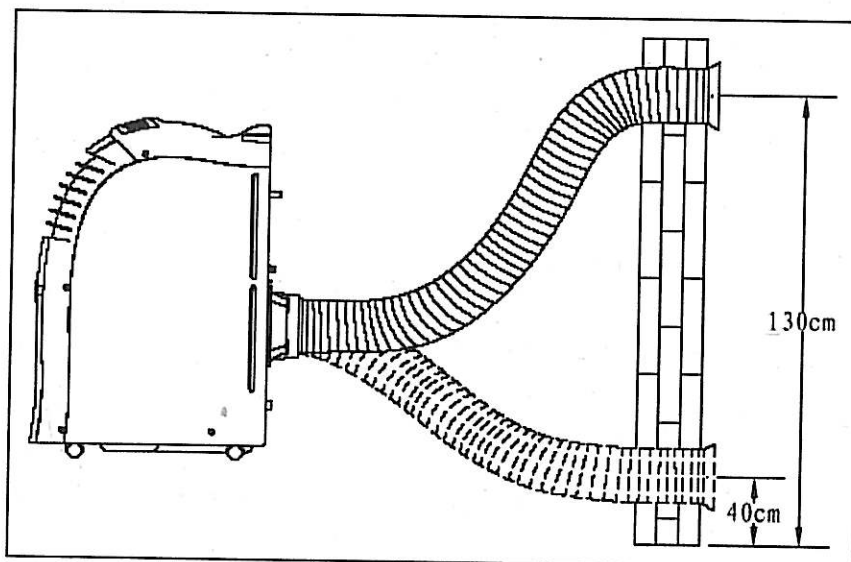

Fig. 5

### Correct mounting

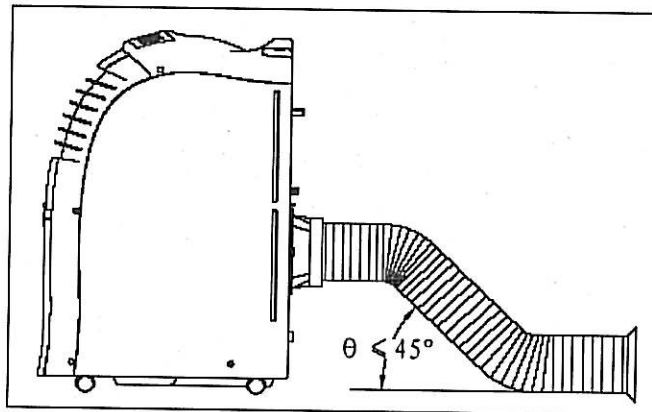

Fig. 6

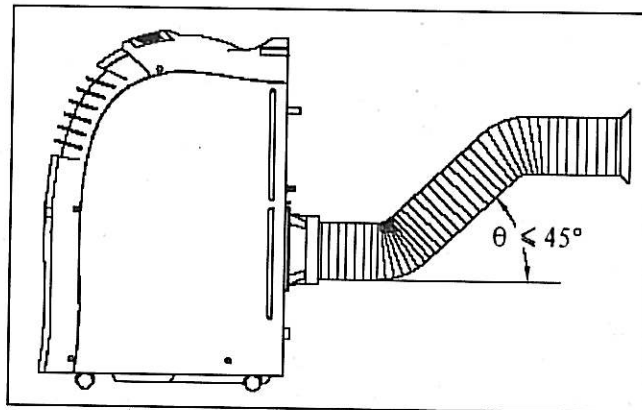

Fig. 7

### Incorrect mounting

The bend of the exhaust pipe is very important. Take care to prevent any sharp bow or bend in the exhaust. The exhaust air must flow freely otherwise the air conditioner may malfunction.

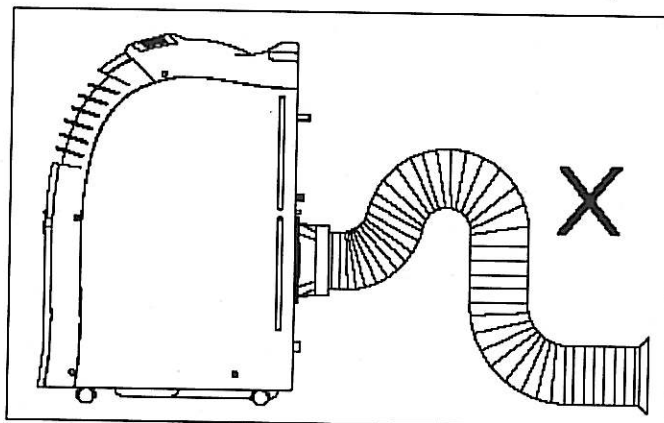

Fig. 8

**NOTE:** The length of the exhaust duct is between 500mm to 1500mm. We suggest using the minimum length of exhaust duct for maximum performance.







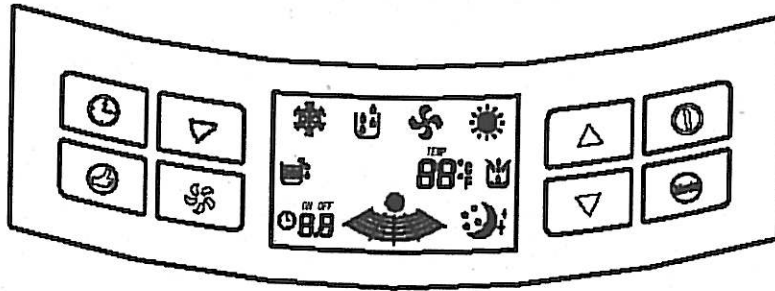

**This length has been designed according to the specifications of the air conditioner. Do not use an extension or exchange with a different hose as that may lead to malfunction.**

Do not use the unit in the bathroom or other humid environments.











## Control Panel

















## Key Functions

-  **ON/OFF:** Press this button to turn the unit on or off.
-  **MODE:** Press this button to select COOL, HEAT, DRY or FAN mode (heat mode only on DAC15HH model)
-  **UP & DOWN:** Press up or down buttons to set the desired temperature or adjust the time in Timer mode. To change the display from Fahrenheit to Celsius, press both up and down buttons at the same time.
-  **SWING:** Press this button to make the vertical louvre swing automatically. Press once again to stop the louvre from swinging.
-  **SPEED:** Press this button for 5 seconds to select high, medium or low fan speed
-  **TIMER:** Press this button to set timer-on, timer-off or no-timer.
-  **ECON:** Press this button to set the unit into energy saving mode (only in heat or cool modes). The temperature is permanently set at 27°C in cool mode, 23°C in heat mode and the fan speed is set on low. These cannot be changed in ECON mode. The LED display will flash  or  accordingly. Press the ECON button again to cancel.

## LCD Display

-  Cool mode indicator.
-  Dry mode indicator.
-  Fan speed indicator.
-  Heat mode indicator (on DAC15HH model only).
-  Water full indicator.
-  Displays temperature setting in cooling and heating modes and ambient room temperature in fan and dry modes. °C indicates Celsius and °F indicated Fahrenheit. Will also display system errors (**E2** – room temperature sensor is faulty; **E3** – evaporator sensor is faulty; **E5** – cooling faulty; **df** – cooling system is preventing frosting or defrosting).
-  Water injection indicator.
-  Indicates timer-on or timer-off is set.
-  Indicates fan speed with or without louver swing.
-  Indicates energy saving status (only in heat and cool modes).





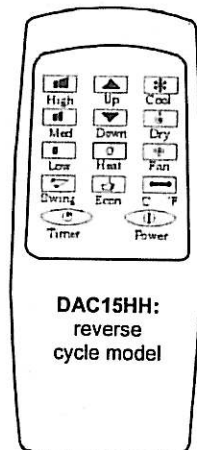
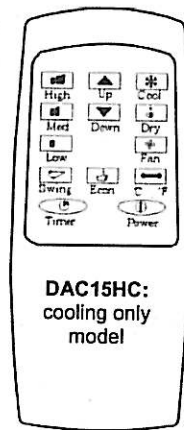

## Remote Control

-  **Power** Press this button to turn the unit on/off.
-  **Timer** Press this button to set the timer.
-  **Swing** Press this button to make the vertical louvre swing automatically
-  **°C °F** Change the temperature display from Celsius to Fahrenheit.
-  **Cool** Press this button to choose Cool mode.
-  **Heat** Press this button to choose Heat mode (DAC15HH model).
-  **Dry** Press this button to choose Dry (dehumidifying) mode.
-  **Fan** Press this button to choose Fan mode.
-  **Up** Press Up or Down button to set temperature
-  **Down** or adjust the time in Timer mode.
-  **High** Press this button to select high fan speed.
-  **Med** Press this button to select medium fan speed.
-  **Low** Press this button to select low fan speed.
-  **Econ** Press this button to set energy saving mode (only in Cool and Heat mode).





## Operating Instructions

### Cooling / Heating Mode





- Press MODE button or  to choose Cool / Heat mode.
- Press UP or DOWN buttons or  to set the desired temperature between 18-30°C.
- Press SPEED button or    to select the fan speed.
- In Cool / Heat mode you can also select the ECON mode which will automatically set the temperature to 27°C for cooling and 23°C for heating on a low fan speed
- Press SWING button or  to make the vertical louvre swing for oscillation. The horizontal louvre can be adjusted by hand.

### Dry (Dehumidifying) Mode

- Press MODE button or  to choose Dry mode.
- The fan speed and room temperature cannot be adjusted.
- Press SWING button or  to make the vertical louvre swing for oscillation. The horizontal louvre can be adjusted by hand.
- Do not use the air outlet duct.



### Fan Mode

- Press MODE button or  to choose Fan mode.
- Press SPEED button or    to select the fan speed.
- Press SWING button or  to make the vertical louvre swing for oscillation. The horizontal louvre can be adjusted by hand.
- The temperature and humidity cannot be set.
- Do not use the air outlet duct.

### Timer -On

- When the unit is switched off, press TIMER button to set timer-on.
- The LED will flash - - 5 times. During this period press UP or DOWN buttons to adjust the time from 0.5h to 24h.
- Time will vary 0.5h each press in the first 3h and 1h each time thereafter.
- The set time will flash 5 times after adjusting.
- When the set time is reached the unit will turn on automatically.

### Timer -Off

- When the unit is operating press the TIME button to set timer-off.
- The LED will flash - - 5 times. During this period press UP or DOWN buttons to adjust the time from 0.5h to 24h.
- Time will vary 0.5h each press in the first 3h and 1h each time thereafter.
- The set time will flash 5 times after adjusting.
- When the set time is reached the unit will turn off automatically.

**NOTE:** When the timer is on you can check the remaining time by pressing the Timer button. It will flash five times. Press the Up or Down buttons to adjust the set time. The set time can also be cancelled by pressing the Timer button again while it is flashing.

### Water Injection

- This product has a self-evaporative system. The condensing water is recycled to improve efficiency by cooling the condenser and saving energy.
- When there is not enough condensing water for pumping, the Water Injection indicator on the control panel will illuminate. When this occurs, pour water into the water injection port (located to the right of the handle) ensuring that you watch the water level pole at the back of the right side of the unit to ensure it is not over-filled.

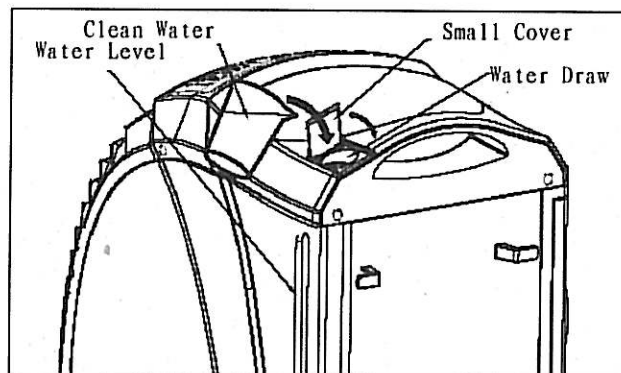

Fig. 9

**Note:** The function works only in cool mode. Do not fill the water injection port while in dry, fan or heat modes.

## Water Drainage

- When the water is full, the water full indicator will light and the compressor will stop working.
- The buzzer will sound 10 times every 5 minutes until the water is below the high level or drained.
- Before you empty the unit you will need to turn the unit off and pull the plug out of the power supply.
- Place a water tray or pan under the hose. (Fig. 10)
- Remove the plug on the drainage port into the vessel beneath.
- You can drain the water out with the drainpipe that is included as part of the accessories. If the drainpipe is too short, you can purchase a pipe 9mm inner diameter.
- Once drained, plug the unit back in and switch it on. The compressor will delay restarting for three-minutes, then the unit will work normally.

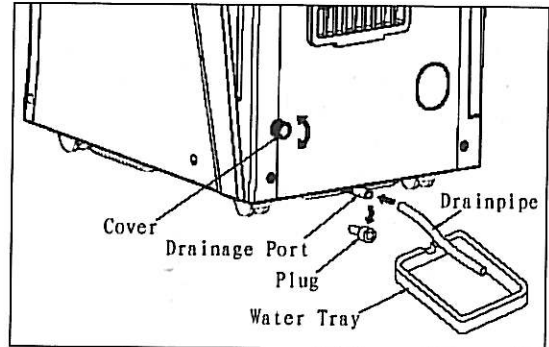

Fig. 10

### Important!

*It is recommended that you do not move the unit around without firstly draining the internal tank. If water is left in the unit then it may spill out onto the floor or carpet.*

## Maintenance

### Cleaning

Turn off the unit and pull the plug out of the socket before cleaning.

#### 1. Clean the surface

- Clean the surface of the unit with a duster or a damp soft cloth.
- Do not use chemical solvent like benzene, alcohol, gasoline and etc, or the surface may be damaged or even deformed.

#### 2. Clean the air filter

- The air filter should be cleaned every two weeks
- If the air filter is blocked with dust the efficiency of the unit will be reduced.
- To clean the air filters
  - 1) Pull out the air filters (Fig.11)
  - 2) Wash the air filter by immersing it gently in warm water (under 40°C or 104°F) with neutral detergent.
  - 3) Rinse the filter and dry it in a shaded place.
  - 4) Push the air filter back into the original position.

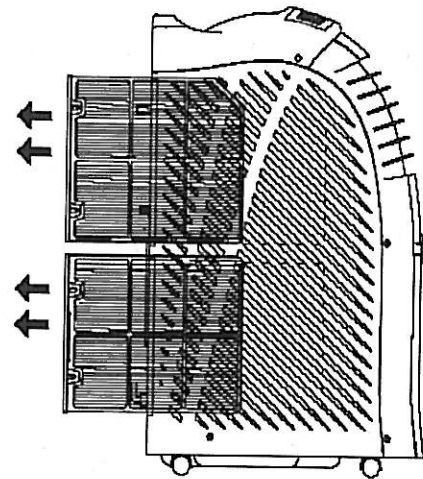

Fig. 11

#### 3. End of Season

1. Pull out the plug from the drain mouth and remove the water from the drain pan. You can remove the water entirely by slanting the unit back.
2. Keep the unit running in Fan mode for several hours to ensure the inside of the unit is dry.
3. Switch off the unit and disconnect the plug from the power supply.
4. Remove the exhaust duct and keep stored in a safe dry place.
5. Take the batteries out of the remote control and keep in a dry place.
6. Wrap the unit with the plastic bag, and keep it in a dry place.

## Trouble Shooting

Before contacting a professional please read the following troubleshooting guide.

Issue	Reason	Solution
The unit does not work	No power supply	Check it is plugged in properly, turn the power-on and turn on the unit.
	The LCD is flashing P2	Drain the water tank.
	Timer function is active	Cancel timer function.
The unit does not seem to perform	In direct sunlight	Draw the curtains
	Windows/doors open, many people or a heat source in the room.	Close windows/doors; remove the heat source if possible.
	Dirty filter.	Clean or replace the air filter(s).
	Air inlet or air outlet is blocked.	Remove the blockage.
	Room temperature is lower than then selected value.	Change temperature selection.
The unit is noisy.	The unit is not on flat surface.	Place the unit on an even, solid surface (less vibrations).
The compressor does not work	The overheat protection is probably activated.	Wait 3 minutes until the temperature has decreased, then turn the unit on again.
The unit starts and stops frequently	Is the voltage normal?	Turn off the unit if the voltage is abnormal.
	Is the exhaust tube attached correctly or is it bent.	Set the exhaust tube correctly.
	Have you added an extra exhaust tube	Remove the extra tube.
The remote control does not function	Distance is too great.	Make sure the remote control is correctly aimed at the control panel.
	Remote control signal not detected by the control panel.	
	The batteries are drained.	Replace the batteries.

**CAUTION:** Switch off the unit and unplug it immediately if anything abnormal occurs. Then contact the Dimplex Customer Care Line.

## Self Diagnosis Function

code	Indication	Check
E2	Room temperature faults	Room temperature sensor faulty
E3	Faulty coil temperature	Coil temperature faulty
E5	Unit faults (Restart the unit)	Room temperature stick to evaporator refrigerant leakage

**Note:** When display "df", it means that the coil is defrosted. That is the normal status.

# Dimplex

## 24 Months Repair / Replacement Guarantee

Hagemeyer guarantees this product against defects caused by faulty workmanship and materials for 24 months domestic use (12 months commercial use) from the date of purchase. During this guarantee period, Hagemeyer will repair or replace any defective product. However, if the product includes a number of accessories, only the defective product or accessory will be replaced.

Hagemeyer reserves the right to make minor repairs instead of replacing the product or accessory.

In the event of a product or accessory being replaced during the guarantee period, the guarantee on the replacement will expire 24 months from the original purchase date. This guarantee excludes defects caused by the product not being used in accordance with instructions, accidental damage, misuse or being tampered with by unauthorised persons.

All costs of installation, removal, cartage, freight travelling expenses and insurance are to be paid by the clamant. Should you experience any difficulties with your appliance you should firstly contact Dimplex Customer Care for advice.

Please retain your receipt as proof of purchase. Every request for guarantee service must be accompanied by proof of purchase.

For any information on your Dimplex product please call our Customer Care line 1300 739 033.

Be sure to attach your proof of purchase to this card and present with the appliance if replacement is required.

Product. \_\_\_\_\_

Model. \_\_\_\_\_

Date of Purchase. \_\_\_\_\_

Purchase from (name and address of retailer) \_\_\_\_\_

***Please complete the above for your own records.***

Dimplex products are distributed in Australia by  
Hagemeyer Appliances, (A Division of Hagemeyer Brands Australia Pty Ltd)

ACN28 001 375 686

Locked Bag 4013, Kingsgrove NSW 2208

Phone: 1300739033

Fax: (02) 93708959

Email: [sdacustomerservice@Hagemeyer.com.au](mailto:sdacustomerservice@Hagemeyer.com.au)

Web: <http://www.dimplex-australia.com>